

**All Band NVIS
Antennae Designs
by
N2CKH/NNN0WWL**

Updated 01 July 2007
Updated 20 May 2007
Updated 23 February 2006
Updated 9 November 2005
Started 13 February 2004

As user of MF/HF frequencies, a dedicated a Near Vertical Incident Skywave (NVIS) is a requirement and not an option in my opinion. In addition a broadband NVIS antenna is a necessity for MARS/SHARES operations and especially for Automatic Link Establishment (ALE) operations. As such I offer three proven antennae designs herein for consideration as effective, inexpensive and easy to install and maintain NVIS antenna types.

This piece was originally written a few years back when I was in Army MARS (AAR2EY/AAA9DHT) to assist my fellow NJ Army MARS members in achieving better performing NVIS antennae installations to improve our statewide operations as many members were using anything but a proper NVIS antenna at that time. In the years since then I have been working with many Tri-Service MARS stations in setting up antenna for use in ALE operations, I have seen a huge improvement up and down the East Coast and in land with stations that I personally communicate with as their performance. This has been the result of these MARS members changing over to NVIS antenna designs, the results have been clearly seen by all concerned.

As to the ALE focus in particular, everyone needs to not only be using an optimal NVIS antennae, but also a broadband NVIS antenna due to the automatic frequency hopping nature of ALE. At present the MARS channels for our current TRI-SERVICE MARS 24/7 ALE network span from NVIS through Skywave where a 10 channel MARS Tri-Service ALE network exists from 2Mhz to nearly 28Mhz, thus random wire antenna performance with gain above 12Mhz is of interest when using a single antenna for ALE to cover both NVIS and Skywave.

NVIS antennae types come in many sizes and shapes with various characteristics, some are broadband and some are not, some less expensive to build and some very expensive to purchase, some are designed for all weather and some are not. Most designs are usually less expensive and usually better made when home made. This document details three relatively inexpensive (parts for any one of them should not cost more than around \$150USD) NVIS antenna designs that are both very effective broad band designs which offer maximum RF energy transfer to the radiating part of the antenna and minimum losses. All of the antenna designs and associated data presented herein is achieved without the use of any counterpoise (which I consider to

be a hazard to foot traffic), however the use of good earth grounds at the station and baluns are required.

I make no claims to be an expert on antennae design, as many have before me, I have read my fair share of reference material on the subject, however I have never found broad band NVIS designs detailed that were totally suitable to my needs. I and others have found two of these antenna designs (the one with 300 ohm twin lead is being published for the first time) herein to work very well at many locations around the U.S. for a number of years now. Although these designs may not be perfect (if there is such a thing as a perfect broadband, efficient HF NVIS antenna) they perform quite well, are efficient radiators and are not at all difficult to assemble, install or maintain and are relatively rugged and inexpensive and will withstand high power operations as may be desired. I have used all three designs in 24/7 ALE operations as well as other modes and tested them at high power levels (making sure that no one was anywhere around the property when testing the low to the ground models) when not involved in NVIS operations.

This document is not a technical paper on the subject of NVIS, however, herein I will cover some basic facts regarding NVIS operation for the new comer to the subject matter. I shall also provide some pointers on testing and maintaining your antenna. In addition, I shall list sources for the major parts used in construction that may be hard to find in some areas. I am not associated with any product or firm that is mentioned within this document.

THE ANTENNA DESIGNS

1. AAR2EY HALF WAVE DOUBLET NVIS ANTENNA

The first NVIS antenna design introduced herein has been used for years now and is basically low to the ground mounted $\frac{1}{2}$ wave all band doublet configured about half way between being an inverted V and dipole to favor NVIS performance. It is cut for a lowest resonant frequency of 3.46Mhz (1.7:1 VSWR at my location) and requires the use of an antenna tuner for most all other frequencies.

I fed this antenna with my preference of 450 ohm low loss ladder line for the bulk of the transmission line run after the broadband RF transformer (featuring high RF power rating) provides a high efficiency design which can be used to operate on frequencies from 2-28MHz (and beyond). The 450 ohm ladder line provides ease of handling for installation and maintenance as compared to the use of a 600 ohm open feed. The 450 ohm ladder line also has advantages over 600 ohm open feeder with respect to potential damage due to bad weather and shorting due to icing.

The use of ladder line (or if desired, 600 ohm open wire feed) provides low loss and excellent high power handling characteristics when required. I use 12 gauge ladder line as the conductors being larger, the loss is less and with the impedance being higher (12 gauge is closer to 450 ohms than is 14 gauge) smaller I^2R losses for the matched condition exist. The use of an external 9:1 vs. 4:1 ratio balun provides for a better match of the 450 ohm ladder line to the 50 ohm cable.

My antenna is resonant at 3.46Mhz with a 1.7:1 VSWR, there are actually multiple points at which the direct match of less than 1.7:1 is achieved, however this antenna design requires the use of antenna for most frequencies. However, the NVIS performance, broad band performance, low loss characteristics and radiation efficiency of the antenna are more important than that of the VSWR. Though, in my opinion, the other key factor of this antenna is that all my various make and models of radios which have automatic antenna tuners, will operate very rapidly with this configuration, as the VSWR direct is never much more than 2.5:1 anywhere that I need to use it and the reactance of the antenna is well within the capability of most but not all automatic antenna tuners.

All feed lines will exhibit higher losses when feeding a load that does not match their characteristic impedance. These losses are due to reflections traversing the line. Coax cable is lossy, even at HF, for example, the loss of 100 feet of open wire line at an VSWR of 20:1 at 30 MHz will be 0.9 dB total. Good quality RG-8 looking into that same 20:1 VSWR will show a loss of over 5 dB. Even if the RG-8 is perfectly matched for minimum loss, 100 feet of it will show a greater loss than the open wire line at about 1.0 dB at 30 MHz. When you have high voltage standing wave ratios at various frequencies to contend with, coax cable can also flash over and short.

This NVIS antenna design by employing the 9:1 balun provides for the use of most internal and external automatic antenna tuners for rapid frequency change (QSY) under control operator direction or automated frequency changes using Automatic Link Establishment (ALE) use when ALE multi-channel scanning operation is employed. However some older ATU types which only support a 3.1:1 VSWR 5-150 ohm tuning range many not be able to tune this antenna at all frequencies. More modern automatic ATU's such as the LDG Electronics line which features models that support a 10:1 VSWR from 6-1000 ohms are more suitable for use with this type of antenna.

As an alternative to the automatic antenna tuner, you can obviously make use of a manual tuner of any variety (with bypass switch for auto tuner use) if you like. You do give up the rapid frequency change capability in doing so, however a manual tuner would be needed should you desire to make use of an external high power RF amplifier greater than 600 watts output. Before you say, my manual antenna tuner has a balun that I can use with ladder line, I want to make it clear that most all manual antenna tuners on the market today make use of a 4:1 balun (often, a poor balun at that) which would be pretty good for 300 ohm twin lead to 50 ohm coax, however they do not provide the proper ratio for 450 or 600 ohm lines. Yes, conductor sizes and spacing affect the "characteristic impedance" of ladder line and open feeder. That is, the impedance of the circuit it must be used in if the VSWR is to be 1:1. When, we speak of "450-ohm ladder line" or "300 ohm twinlead" we are speaking of the "characteristic impedance" of the line. That has little real relationship to the impedance of the line in a real antenna system. Below is a table of frequency steps at 500khz from 1.5Mhz until the end of the NVIS range at 12Mhz at which point we change to 1Mhz steps and corresponding VSWR readings for this antenna design as detailed and installed at my QTH. This table is provides some idea of the characteristic curve of this antenna which is resonant at 3.46Mhz, its is obvious that

Fo/Mhz	VSWR
1.5	7.2
2.0	4.6
2.5	10.4
3.0	8.3
3.5	2.7
4.0	4.8
4.5	6.8
5.0	10.2
5.5	9.7
6.0	7.7
6.5	8.2
7.0	2.5
7.5	7.2
8.0	7.9
8.5	8.4
9.0	6.7

9.5	8.0
10.0	6.2
10.5	3.2
11.0	2.0
11.5	3.3
12.0	2.2
13.0	3.3
14.0	3.3
15.0	6.8
16.0	4.3
17.0	5.8
18.0	1.6
19.0	4.1
20.0	10.1
21.0	2.6
22.0	2.5
23.0	5.7
24.0	4.5
25.0	2.9
26.0	2.1
27.0	4.1
28.0	2.9

Table 1-1

The use of any type of feed line other than coax in to today's homes can be very problematic, thus a run of shielded coaxing cable from the station to the outside world is preferred. This is where a balun just outside the building comes into play for the use of low loss ladder line or open feeder to the feed point of the antenna.

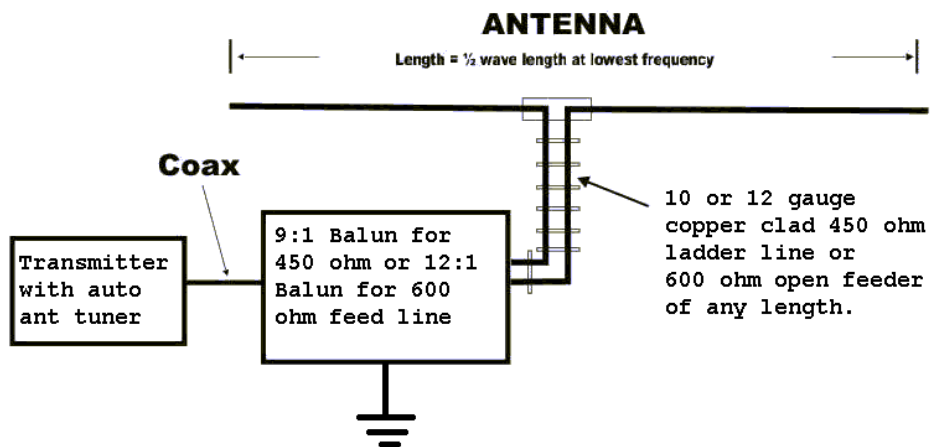

Figure 1-1

Also, when two coaxial lines are used in parallel as a sort of "shielded" balanced feed line, the fact that the line may be balanced does nothing to reduce the losses. The paralleling of two coaxial lines in a balanced system is done to raise the feeder impedance which can reduce the VSWR in a certain antenna designs. Managing the VSWR in such a system is still critical if you want low losses. The RF field around each wire is still trapped in the dielectric between the center conductor and the shield in each coaxial line. That's where the losses occur, but it also makes the balance less critical since there won't be any radiation or pickup from the line because of the shielding. The use of heavy common mode ferrite chokes on such cabling must be used. Personally I do not recommend the used of parallel coaxially lines.

The impedance on either of those lines can vary from a fraction of an ohm to over a thousand ohms when connected to an antenna where the impedance of the antenna does not match the "characteristic impedance" of the feed line. It is the actual impedance extremes found in the system in which the feed line is used, not the characteristic impedance of the feed line, that will determine the resistive losses, however, it is BEST to start with a balun that matches as closely as possible the ratio of balanced to unbalanced characteristics impedances being used.

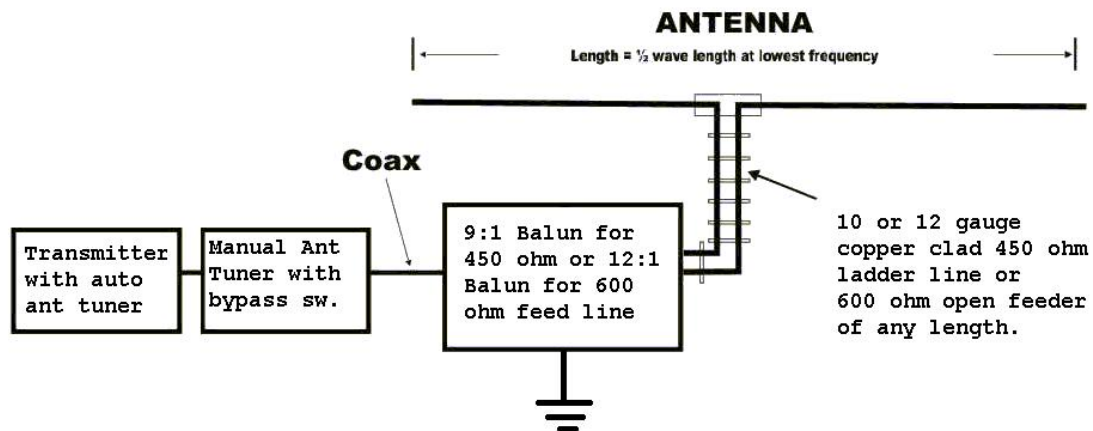

Figure 1-2

At my station, automatic antenna tuner operation at 100 watts is my preferred mode of operation and these days the preferred ATU are LDG AT200PC and AT200PRO models. However, as I do turn my amplifiers on occasionally, so I also have both heavy duty step inductor (Dentron MT-3000A) and roller inductor antenna tuners (MFJ-989C) to handle the external power amplifiers, all with bypass switches for use of the transceivers built or external automatic tuners as well.

I only use external baluns feeding methods with my various antenna selected for the needed ratio of 50 ohm coaxial cable to the type of antenna transmission line or antenna feed point impedance being used. I never use the general 4:1 balun approach

found inside most antenna tuners. This way I efficiently match my system and decouple the RF from the coax external to the station. I also make use of common mode ferrite chokes in the station on the coaxial lines (and other cabling as may be needed) as well due to running multiple HF transmitters, an excellent reference on using ferrite materials and common mode chokes can be found at:

<http://www.yccc.org/Articles/W1HIS/CommonModeChokesW1HIS2006Apr06.pdf>

At my station I am operating ALE stations for MARS running 24/7, a 24/7 SIGINT ALE station (RX only) and now I am often running an ALE station 24/7 in the Amateur Radio Service. In addition I operate HF SSB Voice daily as well, thus I apply a number of broadband techniques to mitigate interference from all stations due to the nature of ALE, I also have single channel external passband and notch filtering available, running 50 watts on transmit though is a key approach taken along with excellent grounding as well as proper antenna placement. The nature of the automatic multi-frequency ALE operation make multi-multi high power operation much more challenging than other types of HF operation, such as Amateur Radio Contest Stations, you have not lived until you have experienced an automatic antenna tuner attempting to tune from RF from another transmitter, the common mode choke addresses that issue and others.

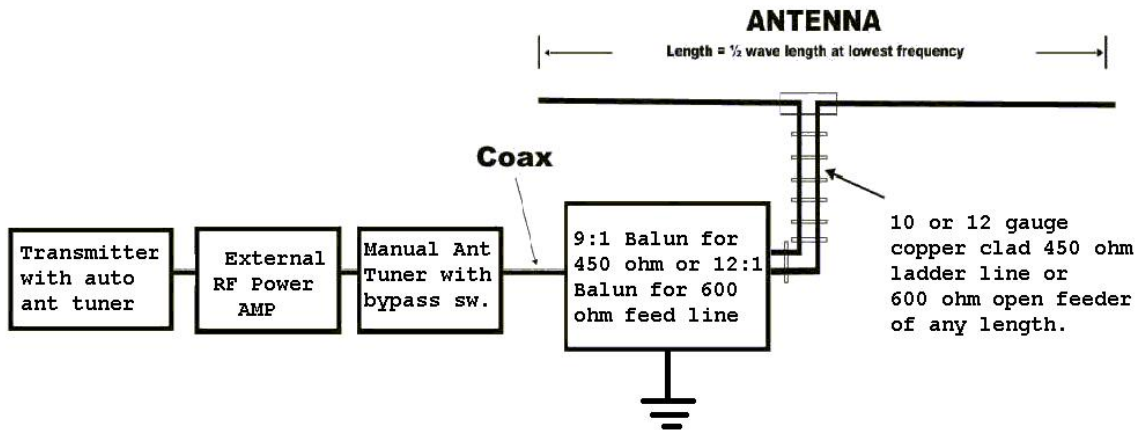

Figure 1-3

I prefer to use RG-214 coaxial cable which will handle high power levels and is low loss (all coax will become more lossy over time exposed to the elements), double braid and has a non-contaminating jacket suitable for burial, however, any coax cable can be used, for a short run to the balun and 100 watt level operation, RG-8X will do just fine.



Figure 1-5

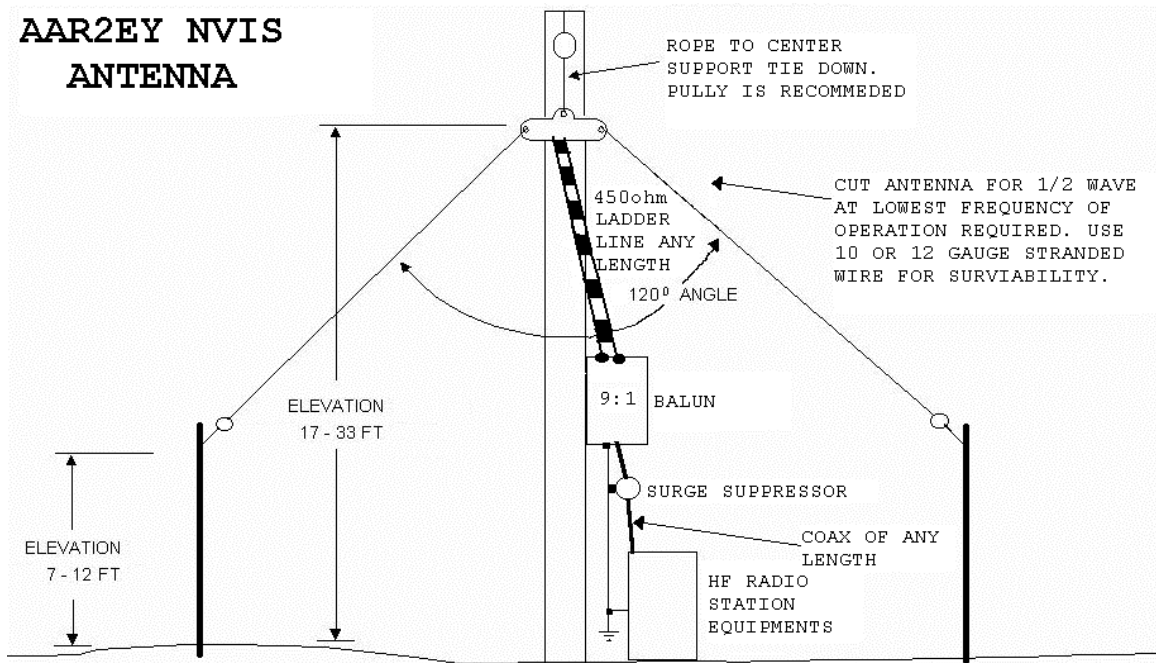

Figure 1-6

I have proven the broadband and NVIS performance of this antenna design at two very different physical locations, the station at my residence where the antenna is mounted in the clear and at the OMARC MARS club station where the antenna mounted to a 20 foot telephone pole that is basically up against a standard military eight foot high barbed wire fence against the tree line with an over lapping 40m dipole on one end and rotating beam antenna on a short 30 foot tower nearby at the Camp Evans Diana Project site.



Figure 1-7

VSWR match is only one indicator of antenna quality. VSWR tells us how well the product's impedance matches to (absorbs) a transmitter's signal, and is easy to measure in the field. Unfortunately, VSWR does not reveal an antenna's efficiency (how well it radiates the signal). This measurement (an antenna's radiation pattern) is more difficult to perform in the field. We may presume that match bandwidth and pattern bandwidth are equal, but this may not always be true. At both locations, the antenna center is about 25 feet ABGL and is about half way between Dipole and Inverted V configuration, this provides fairly good omni-directional performance according to field strength readings that I have taken at my residence and excellent NVIS performance. Basically lowering an HF antenna to about 1/20th wavelength above ground or lower, decreases the background noise level and distant station reception, however for this antenna design to fit within the desired space and keep the ends above pedestrian foot traffic using a modified Inverted V configuration a 1/20th wavelength height can not be achieved.

The key to the broad band performance of this antenna design is the use of the broad band (rated 1.5-54Mhz for a 9:1 and 1.7-25Mhz for a 12:1 ratio) RF transformer and the ladder line feeder. A balun (Balanced to Unbalanced) with a permeability core to obtain the widest bandwidth and the proper impedance matching ratio for the feed line you select to use from the balun to the antenna very important in addition to the height above ground and the angle of the radiating elements of the antenna to provide for NVIS operation. Baluns belong to a class of matching devices known as transmission line transformers. They transmit the energy from input to output by a transmission line mode instead of by flux linkages as in the case of conventional transformers. When properly designed, they can have extremely high efficiencies and

very broad bandwidths. The theory of operation of these devices rests chiefly on that of chokes and transmission lines. A balun is simply a choke that isolates the input from the output (thus only allowing transmission currents to flow) and a configuration of transmission lines.

A broadband RF transformer is designed to operate over a wide range of frequencies with minimum inductive reactance or capacitive reactance occurring at one or more frequencies within the design range of the transformer. This requires the use of high permeability cores with relatively small windings for the 3-30Mhz RF spectrum. As the operating frequency is increased the core becomes less and less evident to the circuit and only the winding on the core is effective at the upper range of operation. However, at the lower end of the frequency range, where MARS operations are most active, the core is "seen" by the circuit and it enables the winding to exhibit the necessary inductance for the low-frequency portion of the operating range.

Most HF broadband transformers are wound on ferrite cores that have a μ (initial permeability or mu) of 125 or 850. The latter type is the most common for coverage from 3-30 MHz. The balun that I prefer for my choice of 450 ohm ladder line, will handle our power levels at almost any mismatch on the line. It is a 9:1 W2FMI model 9:1-HB450 ferrite core balun transformer available from Amidon and others or direct from the manufacturer, CWS ByteMark (<http://www.cwsbytemark.com/>) for less than \$100USD.



Figure 1-8

It is very important with Ladder Line or Open Feeder to provide a good center support with strain relief, you can home brew or purchase solutions, whatever you do, make sure it is sturdy with respect to ultra violet, summer heat, winter cold and icing, insulating the connections between the feed line and radiating elements or even the use of jacketed wire as well will reduce/eliminate winter icing problems.



Figure 1-9

I like to using a WA1FFL Ladder-Lok center insulator/support personally, however, on the larger gauge ladder line you need to go to a custom route.



Figure 1-10

450 ohm ladder line comes in 18, 16, 14 gauge common with 12 and up to 10 gauge out there, you have to look around though to find the heavier gauges, availability varies. Also as gauge changes so does the characteristic impedance, MFJ has a good 10 gauge product, see the following choices sources to name a few:

<http://www.mfjenterprises.com/products.php?prodid=MFJ-18H100>

<http://www.mfjenterprises.com/products.php?prodid=MFJ-18H250>

<http://www.thewireman.com/antennap.html#554>

<http://www.radioworks.com/cwireladr.html>

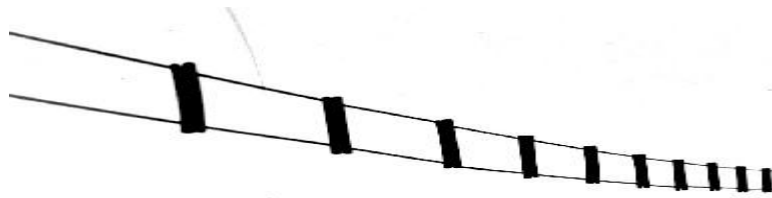

Figure 1-11

Then there is 600 ohm open feeder, see the following choices sources to name a few:

<http://www.w7fg.com/ant.htm>

The antenna should be cut for the lowest frequency you wish to operate as a half wave length dipole or as close to your needed lowest operating frequency as your property space allows. At my residence, I have a 135 foot span of wire, 67.5 feet either side of center, which equates to a resonant frequency for 3.46Mhz using $468/135$. However, my various radios automatic antenna tuners rated to 160 meters will easily match the antenna down to just above 2Mhz, I have even made contacts on 160m and found it to still perform well, I use it just about daily for MARS operations between 3-7.5Mhz with excellent results, it can't be beat for a 160-20m rag chew antenna.

For my antennae, I have use a center fed $\frac{1}{2}$ wave dipole with a 135 foot span, 12 gauge stranded, insulated wire (and also Flex-Weave wire (<http://radiobooks.com/products/fw.htm>) for portable versions) and 12 gauge copper clad steel 450 ohm ladder line with its apex about 25 feet above ground with ends about 8 feet above ground. I have also used as a basis for the antenna the off the shelf Van Gorden Engineering "ALL BANDER" (\$30USD when last checked) for a temporary field versions. However for an all weather (rain, snow and icing) permanent installation insulated wired is preferred, especially if not mounted in the clear, away from trees and branches would could come into contract during storm conditions. Whatever is chosen, be sure to weatherize the center point and balun connections to prevent shorting should foul weather conditions develop during temporary field or fixed site use.

With the 450 ohm ladder line, you will see a feed point impedance from less than 50 ohms to greater than 10,000 ohms depending on the length of the feed line used. It is a good idea if possible, to look at the transmission line to determine the antenna characteristics direct if possible to see what you have. I use an Autek VA-1 antenna analyzer (<http://www.autekresearch.com/val.htm>) for this purpose (it will do 25-450 ohm but not 600 ohms) during design, however, if you don't use less than 100 feet or more than 150 feet of ladder line from the RF transformer to the feed point of the antenna there should be no problem. The higher impedances can damage a balun that is not up to the task, even at 100w exciter levels, let alone at higher levels. Note, when using any type of antenna analyzer, bear in mind that the antenna can receive

signals during its use, which will result in false readings. It is best to work with an analyzer on a given frequency during the time of day when propagation for that wavelength is minimum to limit false readings.

When attaching the ladder line, coax connector and ground braid to the balun, be sure to use some "Penetrox A" on all connections and to provide strain relief for the ladder line. In addition, use some Coax-Seal or other compound over the PL-259 connectors, ladder line terminations and the top part of the balun, the metal to metal joints, to seal out the elements, do NOT do this all around the balun, moisture must be allowed to escape out the bottom.

In the coaxial cable feed line I insert an Alpha Delta ATT3G50U-HP surge suppressor that can be installed at the balun using an Amphenol double male PL-259 or a sort jumper cable. The ground is made used heavy gauge RF byte protected braid to the body of the balun and to an eight foot UL listed 5/8 inch copper glad ground rod. I prefer a ground braid by Electric Motion Co. Inc. (EMC) of Connecticut, their part number EM2051 Ultrabond #6, W/WEB which is UL listed and available in small 25 foot rolls. This cable has press fit eyelets the length of the cable which make attaching to surge suppressors, grounding studs etc. real nice and secure, a little "Penetrox A" on all connections and proper maintenance, your antenna will perform flawlessly for a very long time.



Figure 1-12

In closing on this design, I want relate an incident that took place in the fall of 2004 at N2MO/AAR2CAB where this antenna was used twice on two week day evenings to run nets where the performance was less than normal. Although the TS-450S/AT being used provided a match on a 4Mhz channel with the internal ATU, the signals were down quite a bit from normal with regard to the stations normal signals that were in the net. The first evening it was chalked up to propagation. Two days later on Thursday that week when I was once again at the site the same was true. All stations reported that they heard each other about normal, but that my signals were down. The

following Saturday, in the day light the problem was discovered to be damage to the antenna that was caused by a county trustee work crew of prisoners that were working on the grounds to clear back all the under brush, N2MO/AAR2CAB is located at the old Project Diana site at Camp Evans which was an adjunct to Ft. Monmouth.

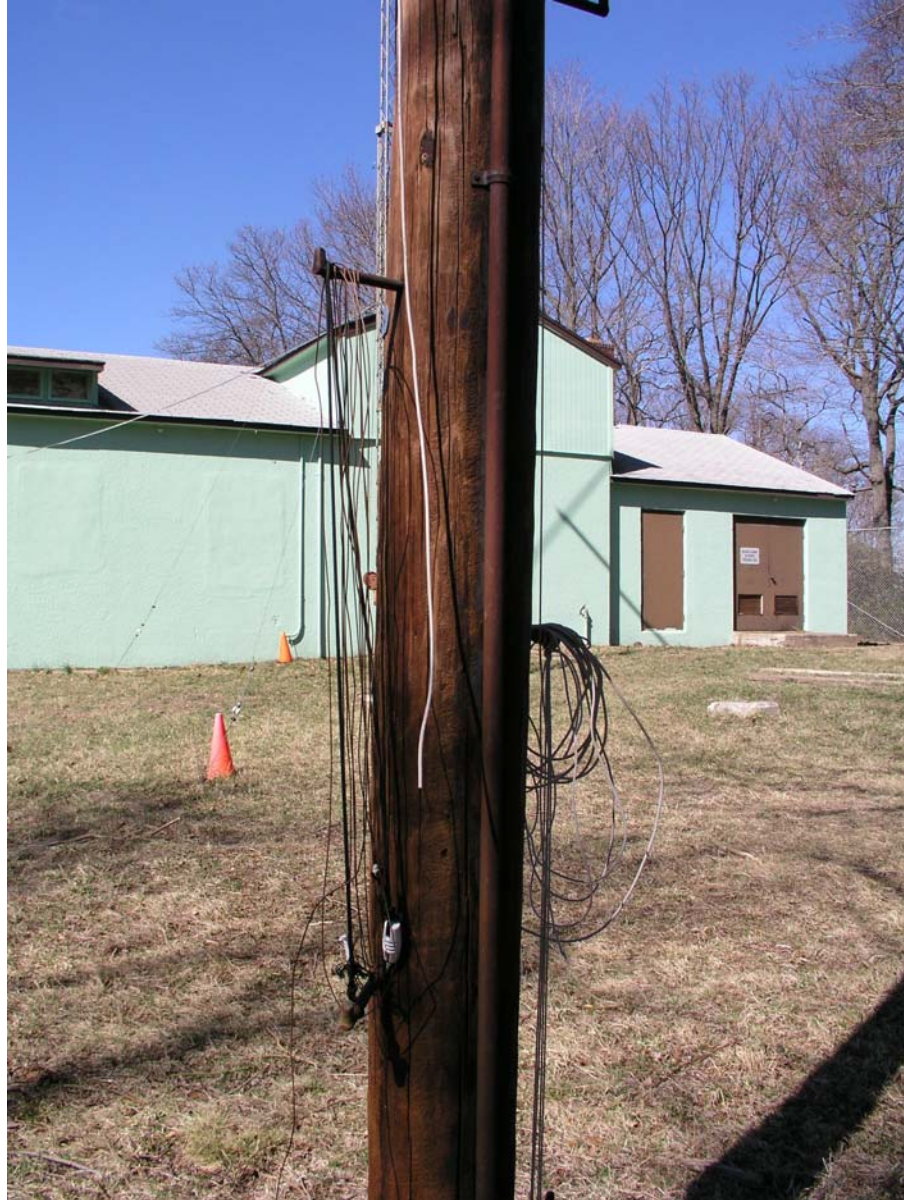

Figure 1-13

Well, as can be seen in the photo above, they ripped off one leg of the antenna and wrapped the other leg around the climbing stirrups of the pole its suspended from, yet we were still able to use the antenna, even with this much damage, a test that I would never have thought to make normally, basically our $\frac{1}{2}$ wave NVIS antenna was transformed to a shortened End Fed Zepp of sorts of sorts, but that 2 stage 9:1 RF transformer made it useable!

2. AAR2EY HALF WAVE DIPOLE NVIS ANTENNA

This second NVIS antenna design is being introduced herein began testing in early Summer 2006, thus as it is now late May 2007, it has seen consistent use for just about one year now and all the NJ weather conditions of Summer, Fall, Winter and Spring. As such I can pronounce it to be an all weather resistant design. However, it is basically intended for short term rapid deployment and requires the use of an ATU at all times. It consists of a rolled up $\frac{1}{2}$ wave flat top dipole with a section of 300 ohm twin lead (packaged 50 foot roll as Radio Shack #15-1174) using 20 gauge stranded conductors and 6:1 balun (ByeMark BAL-300), coax fed and mounted less than $\frac{1}{20}$ wavelength above ground for NVIS performance.



Figure 2-1

One can basically visualize this antenna as a G5RV laid on its side, however just taking a G5RV and mounting it similar to what will be described herein will not achieve the same results.

This antenna has a center fed dipole span of only 125 feet overall (see Figure 2-2) for a frequency coverage of 2-28Mhz using 14 gauge stranded, jacketed (brightly colored for safety) wire or better. The center point and ends of the antenna are mounted at 6 feet above ground. Both ends can be slightly elevated, but no more than 2 feet above the center point. The antenna center point can be raised between 6 to 8 feet above ground with the ends and balun adjusted in height accordingly. This antenna provides for the lowest noise level of the three antenna types detailed herein as well as less signal reception outside of NVIS range. Basically lowering any antenna to about $\frac{1}{20}$ th wavelength above ground or less, decreases the background noise level and increases the local station signals.

This antenna lowest resonant frequency with my soil composition in NJ is 3.2Mhz mounted as specified. My LDG AT200PC ATU easily tunes it down to a VSWR of 1.1:1 from our current MARS 2Mhz ALE channel and up through 28Mhz. It's a true NVIS performer thru 12Mhz and above that it turns into a long wire antenna with some gain and a pattern that is all over the place.

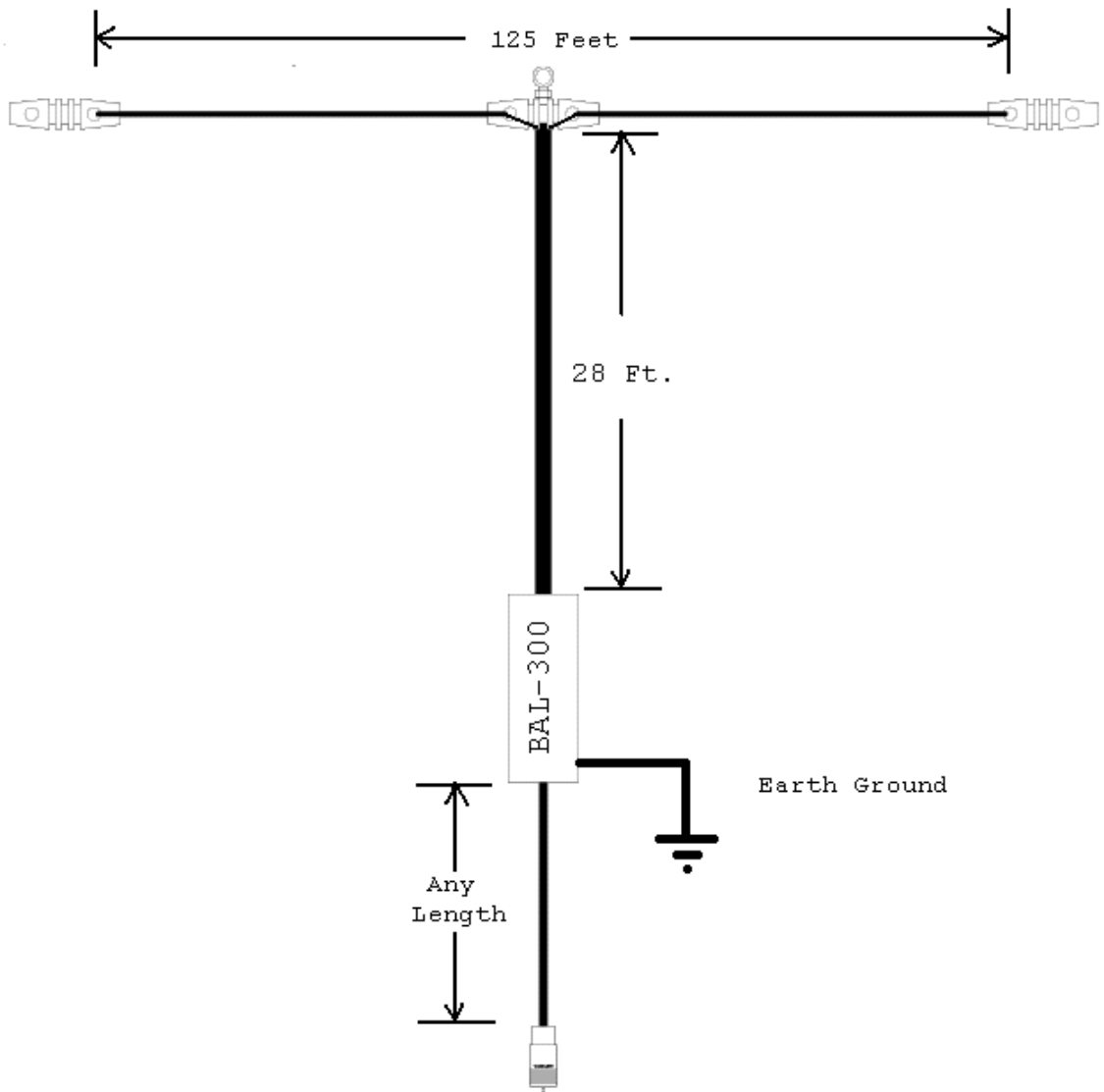

Figure 2-2

Feeding the antenna from the dipole center back is exactly 28 feet of 300 ohm twin to a 6:1 CWS Bytemark BAL-300 2 stage W2FMI balun (see figure 2-3) suspended 10 feet above ground with a heavy earth ground at that point and then any reasonable length of coax to the radio. As this antenna design will exhibit high VSWR at some frequencies and installations due to nearby conductive objects, it should be noted that for each 100 feet of coax, you lose half your power at an VSWR of 10:1, thus as with all antenna installations the coax between the radio and balun should be kept as short as possible as the antenna tuner with this design is at the radio.

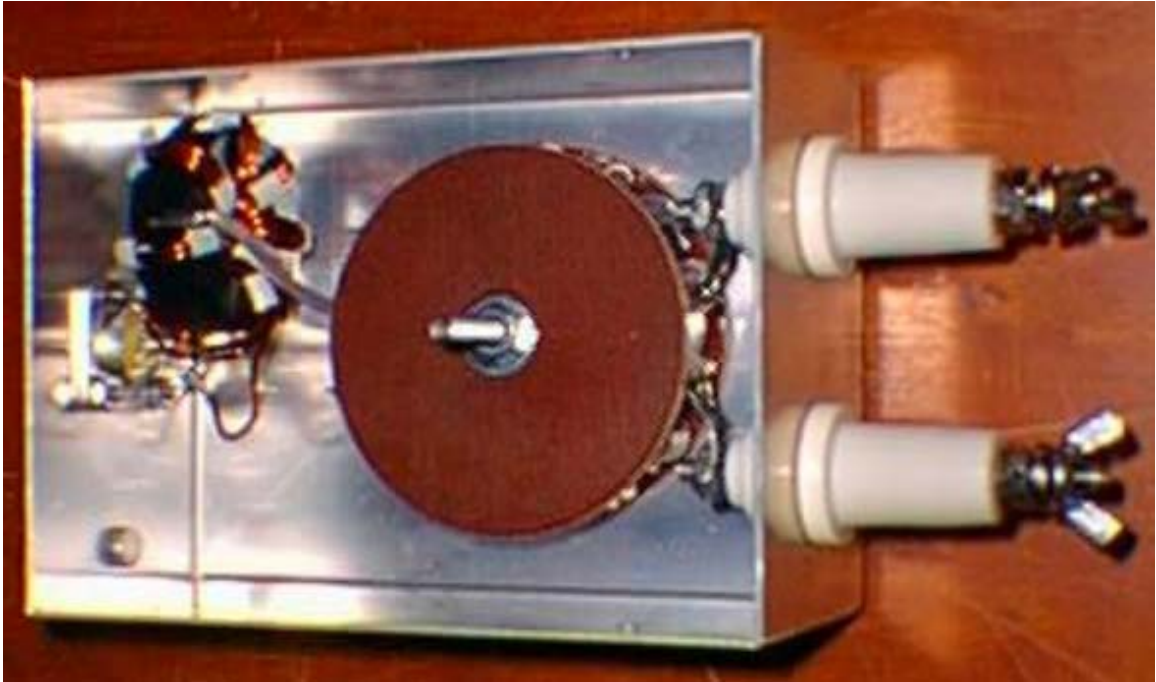

Figure 2-3

As can be seen in Figure 2-4, a heavy black wire tie is itself wire tied to the 300 ohm twin lead and sealed with heavy grade shrink tubing (or electrical tape) after having been tied around the center insulator to strain relief the twin lead connection to the dipole feed point, not shown in this photo is the fact that all bare wire is coated with an ample amount of coax seal to prevent water intrusion and snow/icing problems.



Figure 2-4



Figure 2-5

The antenna will need some center support, as seen in Figure 2-5 Dacron rope is plastic wire tied to the twin lead. A number of variations can be used, I chose to wire tied the rope to the twin lead to keep rain, snow and icing from building up on the center insulator as it would if I attached the rope around it. In this the photo used here the coax seal has not yet been applied. In figure 2-6 below the coax seal has been applied for an all weather seal.



Figure 2-6

The method used to suspend the BAL-300 at ten feet above ground was to use the heavy ground braid as seen in Figure 2-6 where its attached to the ground point on the BAL-300 and the ground rod as well as being attached by a heavy dog lead type metal clip that hoists it in the air by Dacron rope that goes through a stainless steel eyebolt in an oak tree. The end of the ground braid is attached to another such arrangement for a backup in case the first rope should break which can be seen somewhat better in Figure 2-7 along with a view of the 28 feet of 300 ohm length to the feed point of the dipole.

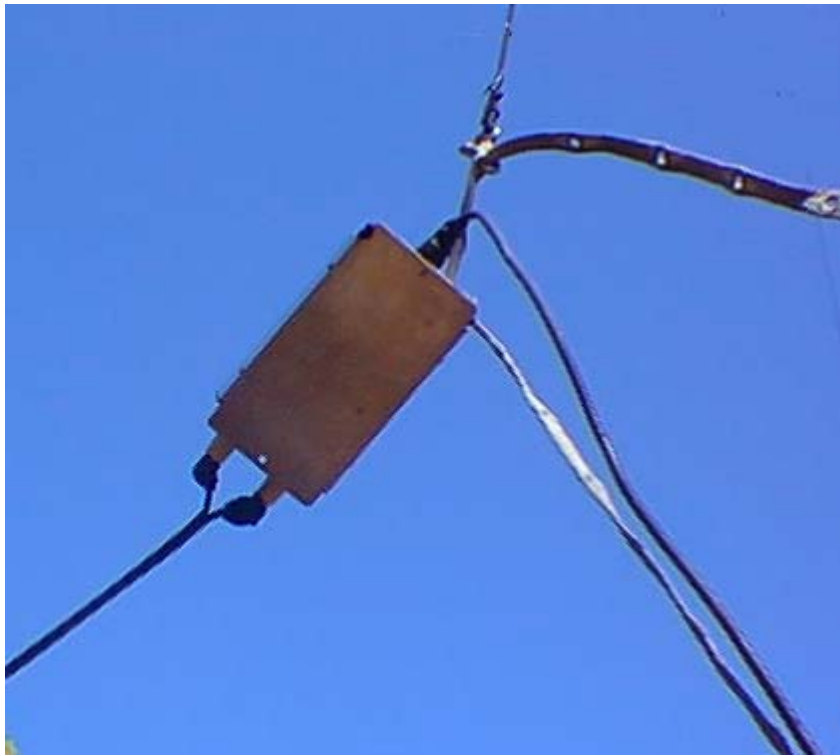

Figure 2-6

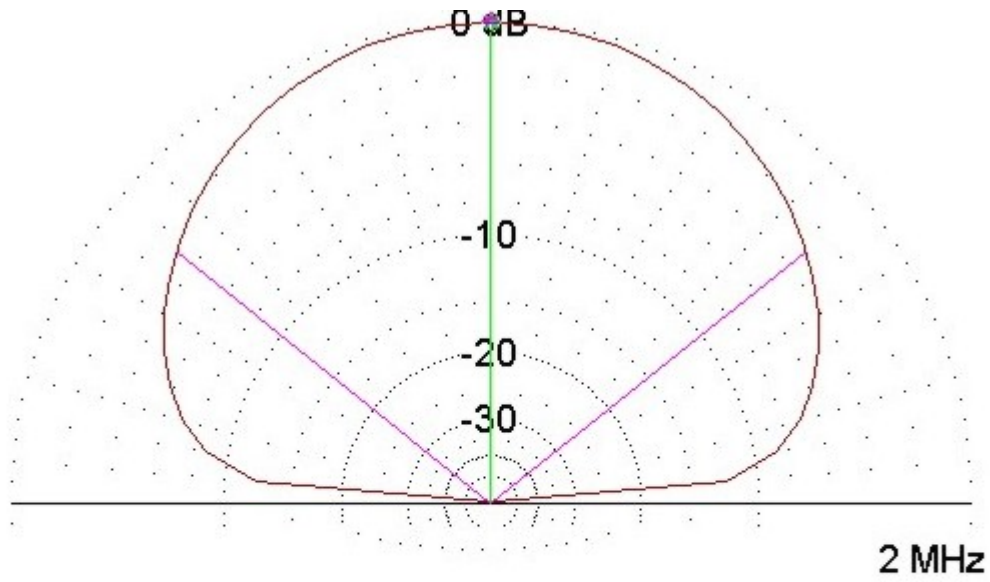

Figure 2-7

Table 2-1 provides the VSWR readings at 500Khz steps from 1.5Mhz through 12Mhz and then 1Mhz steps from 13Mhz through 28Mhz. Figures 2-8 through 2-10 provide some modeling of the antenna at 2, 7 and 15Mhz. The VSWR curve easily remains within the ability of the LDG 200 series (AT200PC and AT200PRO) antenna tuners to tune, even the older internal tuners have little trouble tuning the antenna on most frequencies being used, however most older ATU's have very limited turning ranges. The LDG units take it down with ease instantly, the AT200PC is just the ticket MARS-ALE operations.

Fo/Mhz	VSWR
1.5	9.5
2.0	4.9
2.5	6.1
3.0	2.1
3.5	4.0
4.0	5.0
4.5	4.6
5.0	4.5
5.5	4.3
6.0	3.9
6.5	4.5
7.0	4.5
7.5	6.1
8.0	7.7
8.5	7.6
9.0	7.9
9.5	6.3
10.0	3.7
10.5	3.5
11.0	1.9
11.5	1.8
12.0	3.1
13.0	5.5
14.0	4.4
15.0	4.0
16.0	2.8
17.0	2.2
18.0	2.3
19.0	1.8
20.0	1.5
21.0	3.6
22.0	3.2
23.0	4.0
24.0	4.5
25.0	2.3
26.0	1.5
27.0	1.8
28.0	2.7

Table 2-1



Elevation Plot		Cursor Elev	90.0 deg.
Azimuth Angle	310.0 deg.	Gain	-9.39 dBi
Outer Ring	-9.39 dBi		0.0 dBmax
3D Max Gain	-9.39 dBi		
Slice Max Gain	-9.39 dBi @ Elev Angle = 90.0 deg.		
Beamwidth	103.0 deg.; -3dB @ 38.5, 141.5 deg.		
Sidelobe Gain	< -100 dBi		
Front/Sidelobe	> 100 dB		

Figure 2-8

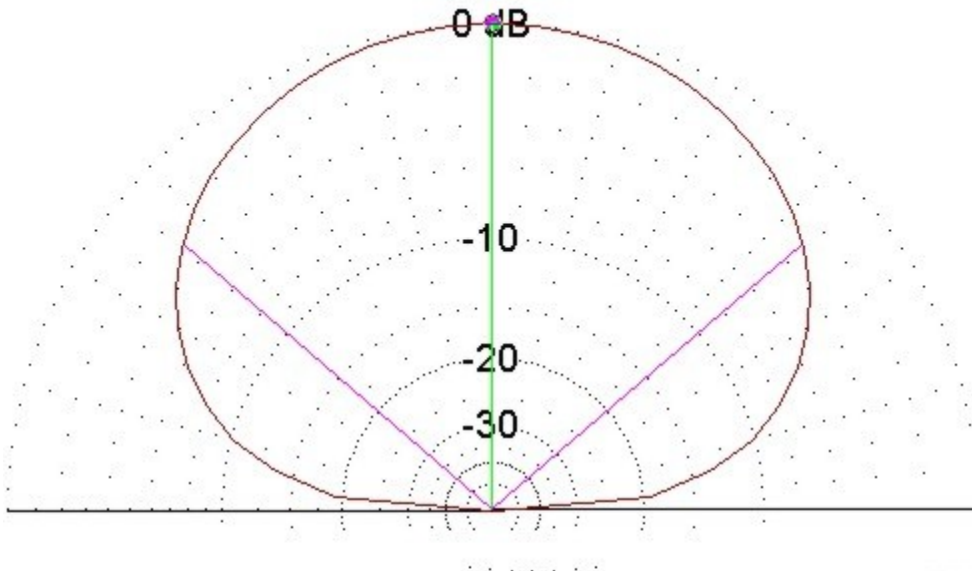

7 MHz

Elevation Plot		Cursor Elev	90.0 deg.
Azimuth Angle	0.0 deg.	Gain	1.89 dBi
Outer Ring	1.89 dBi		0.0 dBmax
3D Max Gain	1.89 dBi		
Slice Max Gain	1.89 dBi @ Elev Angle = 90.0 deg.		
Beamwidth	99.0 deg.; -3dB @ 40.5, 139.5 deg.		
Sidelobe Gain	< -100 dBi		
Front/Sidelobe	> 100 dB		

Figure 2-9

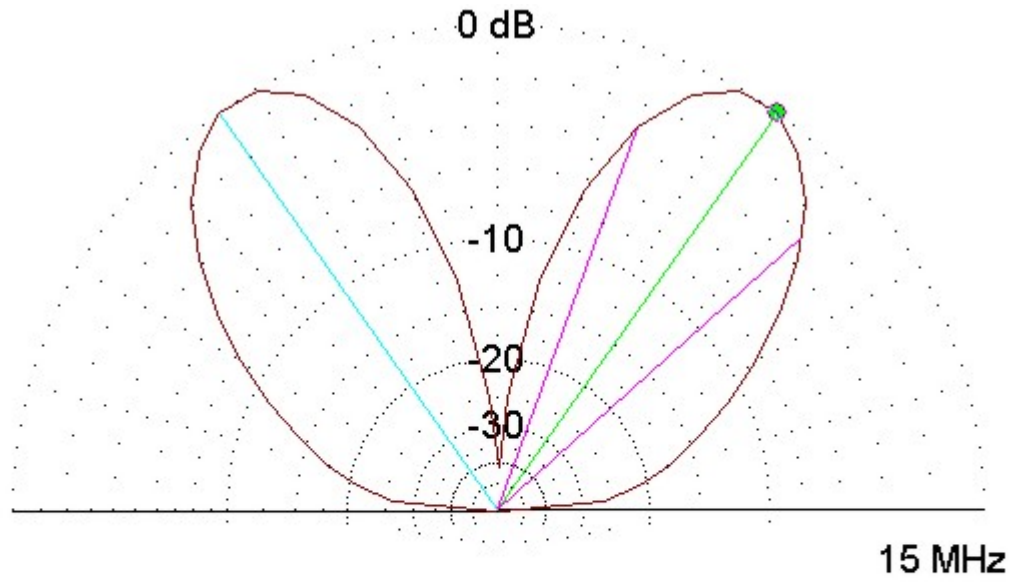

Elevation Plot		Cursor Elev	55.0 deg.
Azimuth Angle	85.0 deg.	Gain	3.97 dBi
Outer Ring	3.97 dBi		0.0 dBmax
3D Max Gain	3.97 dBi		
Slice Max Gain	3.97 dBi @ Elev Angle = 55.0 deg.		
Beamwidth	27.9 deg.; -3dB @ 42.1, 70.0 deg.		
Sidelobe Gain	3.97 dBi @ Elev Angle = 125.0 deg.		
Front/Sidelobe	0.0 dB		

Figure 2-10

3. AAR2EY RANDOM WIRE NVIS ANTENNA

The third NVIS antenna design is basically a Random Wire Antenna where no counter poise is used. As not everyone can install a full size dipole type antenna for 2 or 3 or even 4Mhz, an alternative for those that do not have available yard space for a conventional dipole type antenna or who want an efficient radiator where no ATU is required may find this Random Wire NVIS antenna type of interest.

A Random Wire antenna is a run of wire about 1/2 to preferably 1 wave length long at/near your lowest needed operating frequency. As long as the wire is not less than a half wavelength in terms of length, this type of antenna will usually give acceptable performance over a 2:1 frequency range (a 1/4 wave length at the lowest frequency is still quite usable).

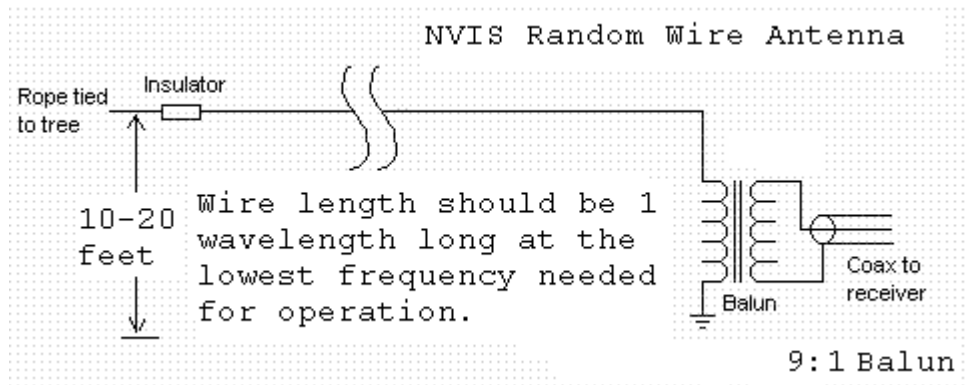

Figure 3-1

The orientation can be just about anything where the wire is not nearby or make contact with conductive objects and is not doubling back on itself. A straight run of wire can be used if desired or to make the most of a small lot a U (or L, V, U, W, Z pattern or other) shaped random wire antenna running the sides and back of a typical 1/2 acre lot can easily be 250 feet or more which will work quite nicely at 160 meters and above, my particular installation at this time is 400 feet in length, which is 1 wavelength at the current lowest NMCM 2Mhz ALE frequency.

The wire can be any type, but jacketed, large gauge, stranded wire is the best to use in my opinion. The antenna should be at least 125 feet long to be usable down to 2Mhz with a tuner, the longer the better, mine as detailed herein uses 400 feet of stranded 12 gauge jacketed wire for operation down to 4Mhz without the need for a tuner. To get the most wire out as possible, it is best to go from the RF transformer straight out to the closest side of the lot and then toward the back of the lot and across the back to the other side and all the way down that side as far as you can go to an end support. This will conform to a letter J or U configuration.

At least a 4:1 balun should be used between the run of coax and the antenna. I have found it best to use the same 9:1 BAL-450 RF transformer as used with the NVIS Doublet design. The use of the 9:1 balun provides better matching, cuts down on

noise as well as decoupling the RF from the coax and dramatically reducing the wild swings in antenna efficiency that a coax fed random wire antenna would exhibit. The matching transformer with its 9:1 impedance ratio at the feed point will present the antenna with fairly constant load resistance at most frequencies, the mismatch losses will be considerably lower as the variation in the mismatch loss is also reduced. Also, cable losses are not terrible at NVIS frequencies (below 12Mhz) unless you're using too much coax to the matching transformer, even then, the transformer helps in the match at the antenna end and will reduce the cable losses, because cable losses increase with increasing VSWR. Make sure you have a good ground at the transformer (as seen in Figure 3-2) and you will not need a counterpoise and you should not have RF in the shack as long as you have a good ground. Installation specific parameters may come into play such as nearby metal obstructions (to include other antenna) that may interfere with the antennas characteristics.

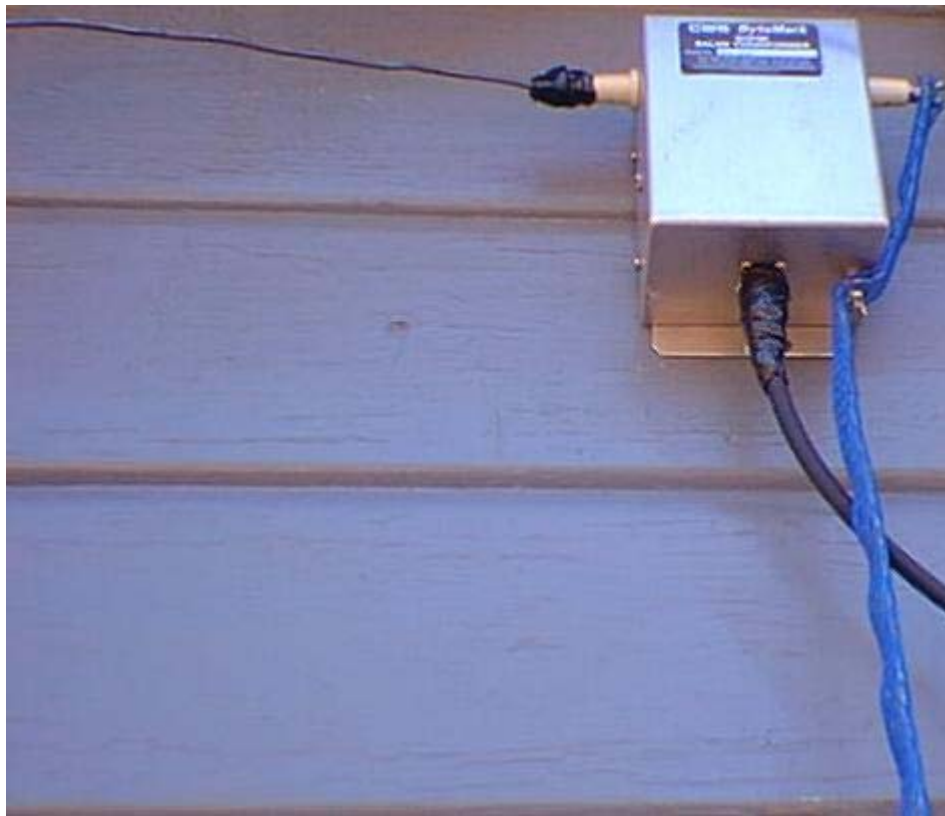

Figure 3-2

In most installations you should not see a VSWR much above 2.5:1 across the entire HF range beginning at 4Mhz using 400 feet of wire. The worst case VSWR is mostly below 2.0:1 or less as seen in the data contained herein, which means that no antenna tuning will even be required with most transceivers across the HF frequency range. However, long runs of coax will give you a false indication on as a good percentage of your RF is being lost combined with a high VSWR, its best to keep the coax run as short as possible. The RF transformer should be placed as close as possible to the entry point to your station to allow for a short coax run. For each 100 feet of coax,

you lose half your power at an VSWR of 10:1, which is a VSWR that should never be seen with the antenna design. Also, be sure to strain relief the wire (as seen in Figure 3-3) so that no undue stress is being handled by the transformer itself.

I have very few points using 400 feet of wire above 4Mhz where the VSWR is above 2.5:1, these I believe are frequency related with other nearby antenna. However some may see an extremely high VSWR with reactance content beyond the ability of your ATU to tune. A swept of the antenna with an antenna analyzer will reveal any such characteristics, bear in mind however that induced signals on the antenna may give false readings where strong signals exist at points across the spectrum. The design of this antenna allows today's wide range automatic antenna tuners to easily tune any frequency down to a match when needed, even older 5-150 ohm tuners work with ease. Even my old Kenwood TS-450 which has a poor internal ATU that is not even rated for use below 3.5Mhz has no problem tuning this antenna well below its rated tuning range.



Figure 3-3

I have provided a complete set of data below using an Autek Research VA1 RX Vector Analyzer on my 400 foot long version of this antenna design. The data below was taken from 1.5 to 12Mhz in 500Khz steps, beyond NVIS frequency range 13-28Mhz data follows in a separate table. The VSWR curve does not rise to the point of needing to consider using an ATU until we venture below 4Mhz. For my ALE station operation the MARS-ALE software is configured with an LDG AT200PC Automatic ATU to kick in for frequencies below 4Mhz.

My antenna is installed about 10 feet above ground, it should be at least 6 to 8 feet so that it is out of easy contact to people, but no more than 20 feet above ground. The lower the antenna, the lower the drive point impedance. As a conventional random wire antenna is lowered closer to the ground, the drive point impedances drops, this can be as low as 5 ohms or less with a drive point current at 100 watts of 5 amps which would result in large ground conductivity losses that would require adding a counterpoise, however using the BAL-450 this is not the case as seen in the data below and no counterpoise is required.

Fo/Mhz	VSWR	Xs = Series Reactance in Ohms	Rs - Series Resistance in Ohms
1.5	3.46	23.0	175.0
2.0	3.26	72.0	113.0
2.5	3.68	69.0	47.0
3.0	2.23	17.0	106.0
3.5	3.00	37.0	28.0
4.0	1.46	13.0	39.0
4.5	1.42	13.0	46.0
5.0	1.98	34.0	48.0
5.5	1.52	23.0	59.0
6.0	1.40	17.5	60.0
6.5	1.93	34.0	52.0
7.0	1.20	11.0	50.0
7.5	1.76	28.0	46.0
8.0	1.48	11.0	33.0
8.5	1.26	11.0	53.0
9.0	1.56	18.0	40.0
9.5	1.66	16.0	77.0
10.0	1.39	16.0	58.0
10.5	1.71	19.0	74.0
11.0	1.23	13.0	53.0
11.5	1.49	12.0	70.0
12.0	1.27	12.0	56.0

Table 3-1

Fo/Mhz	Z=Impedance in Ohms	Phase Angle in Deg	L=Inductance in uH
1.5	169.0	8.0	1.88
2.0	132.0	32.0	5.95
2.5	83.0	57.0	4.40
3.0	108.0	9.0	0.90
3.5	51.0	55.0	1.70
4.0	39.0	19.0	0.31
4.5	48.0	15.0	0.65
5.0	58.0	58.0	1.10
5.5	64.0	22.0	0.66
6.0	62.0	17.0	0.55
6.5	62.0	33.0	0.85
7.0	51.0	13.0	0.26
7.5	53.0	32.0	0.62
8.0	35.0	19.0	0.23
8.5	54.0	11.0	0.21
9.0	43.0	26.0	0.37
9.5	78.0	12.0	0.29

10.0	59.0	16.0	0.28
10.5	76.0	12.0	0.24
11.0	55.0	12.0	0.17
11.5	70.0	10.0	0.18
12.0	58.0	12.0	0.17

Table 3-2

Fo/Mhz	C = Capacitance in pf	Reactance of Antenna in Ohms
1.5	9.00	10.0
2.0	264.00	74.0
2.5	916.00	72.0
3.0	2120.00	21.0
3.5	1186.00	38.0
4.0	2929.00	7.0
4.5	2647.00	19.0
5.0	942.00	31.0
5.5	1220.00	22.0
6.0	1355.00	20.0
6.5	707.00	34.0
7.0	1860.00	11.0
7.5	747.00	28.0
8.0	1766.00	8.0
8.5	1682.00	10.0
9.0	768.00	20.0
9.5	1006.00	19.0
10.0	1011.00	17.0
10.5	1027.00	18.0
11.0	1297.00	10.0
11.5	1053.00	14.0
12.0	1050.00	11.0

Table 3-3

With an eye for Skywave use of this antenna when mounted at a height for NVIS performance the following table details readings taken on my 400 foot version of this antenna design in 1Mhz steps from 13 through 28Mhz which is the range used in MARS and SHARES operations.

Fo/Mhz	VSWR	Xs = Series Reactance in Ohms	Rs - Series Resistance in Ohms
13.0	1.94	22.0	31.0
14.0	1.83	7.0	29.0
15.0	1.70	10.0	31.0
16.0	1.55	26.0	62.0
17.0	1.61	16.0	78.0
18.0	2.25	45.0	76.0
19.0	1.92	32.0	47.0

20.0	2.01	19.0	30.0
21.0	1.56	33.0	33.0
22.0	2.31	29.0	29.0
23.0	3.23	22.0	64.0
24.0	2.90	52.0	119.0
25.0	2.64	48.0	41.0
26.0	2.08	19.0	22.0
27.0	1.96	10.0	27.0
28.0	1.80	22.0	37.0

Table 3-4

Fo/Mhz	Z=Impedance in Ohms	Phase Angle in Deg	L=Inductance in uH
13.0	42.0	40.0	0.35
14.0	31.0	14.0	0.08
15.0	32.0	19.0	0.12
16.0	67.0	23.0	0.26
17.0	78.0	12.0	0.16
18.0	88.0	32.0	0.40
19.0	56.0	35.0	0.28
20.0	36.0	33.0	0.16
21.0	33.0	11.0	0.06
22.0	41.0	45.0	0.22
23.0	96.0	48.0	0.51
24.0	131.0	24.0	0.35
25.0	62.0	51.0	0.31
26.0	30.0	42.0	0.12
27.0	28.0	21.0	0.06
28.0	42.0	31.0	0.12

Table 3-5

Fo/Mhz	C = Capacitance in pf	Reactance of Antenna in Ohms
13.0	437.00	31.0
14.0	1410.00	15.0
15.0	1000.00	8.0
16.0	380.00	24.0
17.0	589.00	22.0
18.0	193.00	43.0
19.0	253.00	34.0
20.0	380.00	25.0
21.0	984.00	2.0
22.0	245.00	21.0
23.0	95.00	60.0
24.0	123.00	7.0
25.0	130.00	57.0

26.0	309.00	27.0
27.0	570.00	3.0
28.0	261.00	15.0

Table 3-5

A fellow MARS/CAP member I know has this antenna design installed at his residence, which is rather typical of most modern suburban developments, ½ arce lot with a small backyard, pool for the kids, wife and neighbors, all making for a large visible HF NVIS antenna a problem. So after a on-site consultation, he erected an antenna consisting of about 250 of (jacketed/coated is recommended for icing) 12 gauge, 259 strand Flex-Weave antenna wire, run along the top of his wooden fence the entire perimeter of his backyard, thus it is in a boxed U shape, stapled to the fence, about 6 feet above ground. This basic version worked fairly well most of the time without installing the 9:1 transformer, however after a few years he finally changed to jacketed wire and installed the transformer with the benefits of no icing issues, easier ATU tuning and lower noise levels immediately apparent. He runs coax from his basement station, under ground, to the RF transformer mounted on his fence with a ground rod at that point and then has the wire running around the fence. The entire inside perimeter of the fenced property has large 6 foot tall shrubs that keep people away from the antenna, even at 6 feet it works extremely well and is completely invisible without a very close inspection.

NEAR VERTICAL INCIDENT SKYWAVE (NVIS)

NVIS is not just an antenna type or a propagation mode, it is a system. The NVIS antenna is only part of that system, however, for best results, all radio stations within a net **MUST** be using NVIS type antennas. The other part is the knowledge and cooperation of the operators, which must be accurately applied to achieve the best results. NVIS is a specialized transmission mode which exploits a proven mode of radio propagation which involves the use of antennas with a very high radiation angles, approaching or reaching 90 degrees (straight up), along with selection of an appropriate frequency below the critical frequency, to establish reliable omnidirectional communications over a radius of 0-400 miles or so, give or take 100 miles using a 100 watt class exciter. At these angles total refraction of the radio wave occurs and a large service area is achieved: the effect is similar to that seen when a garden hose is directed vertically upwards.

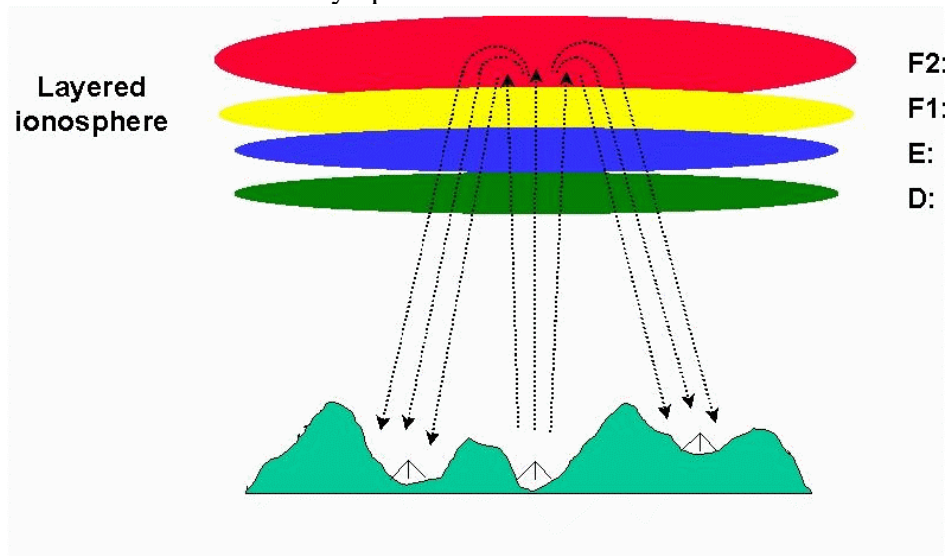

Figure 1

Actually, stations in NVIS networks should be limited to 100 watts output, because more power frequently causes increased ground wave signals resulting in phase-distorted reception issues known as Multipath. A good printed reference on the subject of NVIS antennas is "The NVIS Propagation Mode and the Ham," The ARRL Antenna Compendium, Vol. 5, pp. 129-134.", a search on the Internet will also turn up many good references.

A number of antenna types can be implemented for NVIS operation, any form of Dipole, Inverted V, Inverted L, Full Wave Loop and Random Wire type antenna can all be maximized for NVIS performance. However, the antenna designs offered herein provides for both NVIS and broadband operation and all but the Random wire design require an antenna tuner.

The simplest NVIS antenna is the horizontal half-wave dipole at a very LOW height above ground, about $1/20^{\text{th}}$ wavelength or less. The optimum height for an NVIS antenna is objectively between 0.1 to 0.25 of a wavelength above ground, for the particular frequency concerned [0.15 of a wavelength is a figure often used]. This can be enhanced by adding a reflecting wire beneath the dipole, parallel with it (obviously, the lower the earth losses, the better) but such methods add a risk to pedestrian foot traffic. The main idea is to maximize the upward radiation towards the vertical (or zenith) and minimize low-angle sky and ground waves. The 40m and certainly 80m dipoles for most Radio Amateurs and MARS stations are difficult to place at the 'optimum' of 0.5 wavelength above ground for Skywave, so there is a PROPORTION of high angle radiation from these low antennas which may give a certain amount of NVIS propagation, but obviously a knowledge of NVIS techniques enables one to specifically engineer the antenna system to take maximum advantage of the NVIS effect, and then there is the aspect of broadband antenna operation needed for MARS operations, especially Automatic Link Establishment (ALE).

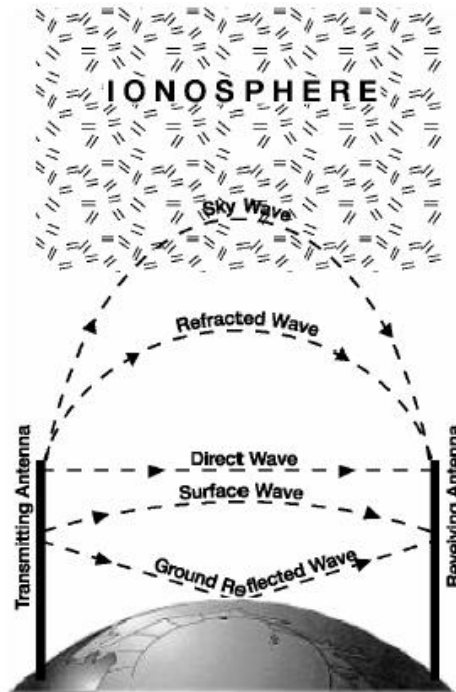

Figure 2

Deliberate exploitation of NVIS is best achieved using antenna installations which achieve some balance between minimizing groundwave (low takeoff angle) radiation, and maximizing near vertical incidence skywave (very high takeoff angle) radiation. Often, taking measures to optimize a station's NVIS antenna capabilities will substantially reduce receiver noise level. Sometimes, the drop in noise can be maximized at the expense of some signal strength, and result in a communication circuit which has lower signal levels, but even more dramatically lower noise levels, for an even better signal/noise ratio than could be achieved by focusing only maximizing signal levels.

Successful NVIS work depends on being able to select, or find (through trial and error), a frequency which will be reflected from the ionosphere even when the angle of radiation is nearly vertical.

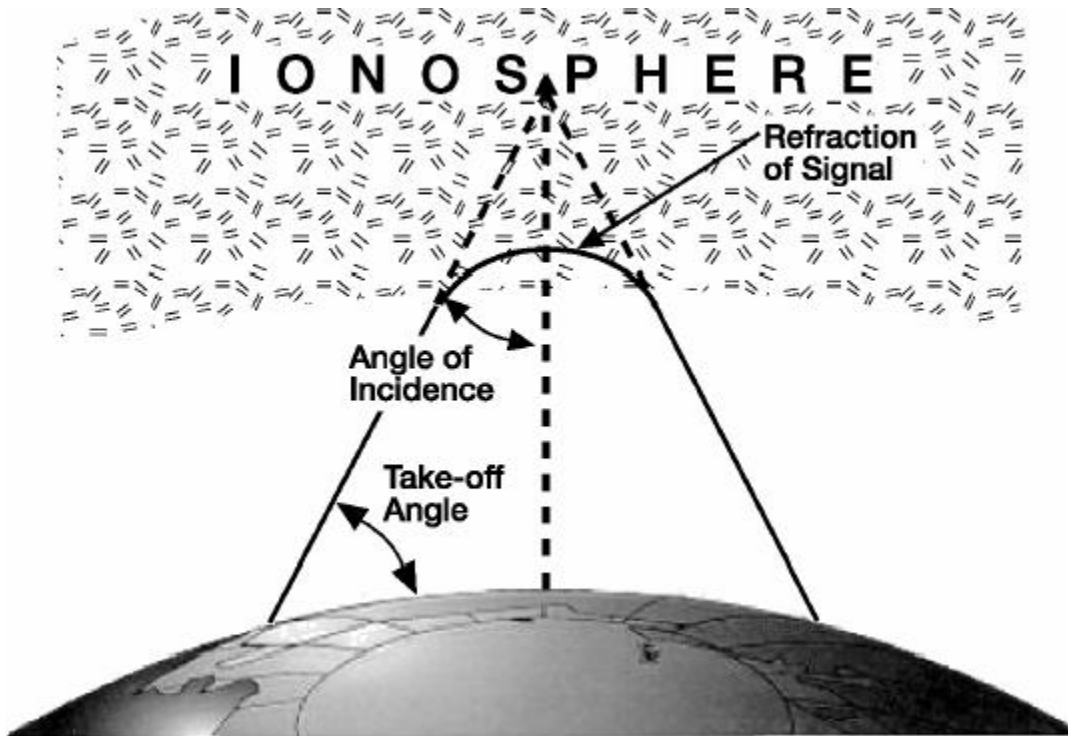

Figure 3

These frequencies usually are in the range of 2-12 MHz overall, with 2-5Mhz. best at night and 4-12Mhz. best during the day, though sometimes the limit is higher, basically we are talking about where the bulk of MARS activity takes place. The trick is to select a frequency which is below the current critical frequency (the highest frequency which the F layer will reflect at a maximum 90 degree angle of incidence) but not so far below the critical frequency that the D and/or E layers mess things up too much.

Among the many advantages of NVIS are:

- Supports omni-directional communications within the skip zone (normally too far away to receive ground wave signals, but not yet far enough away to receive skywaves reflected from the ionosphere).
- Two stations employing NVIS techniques can establish reliable communications without the support of any third party or system for relay.
- NVIS propagation is relatively free from fading.
- Antennas optimized for NVIS are usually low (30 feet or less) which can be erected easily for ECOM activity in the field.

- Low areas and valleys are no problem for NVIS propagation as terrain does not effect loss of signal. This gives a more constant received signal level over the operational range instead of one which varies widely with distance
- The path to and from the ionosphere is short and direct, resulting in lower path losses due to factors such as absorption by the D layer.
- Can dramatically reduce noise and interference, resulting in an improved signal/noise ratio.
- The improved signal/noise ratio and low path loss, NVIS works well with low power and power levels greater than 100 watts should be avoided due to Multipath characteristics.

Disadvantages of NVIS operation include:

- All stations need to be optimized for NVIS operation to achieve the best results. If one station's antenna emphasizes ground wave propagation, while another's emphasizes NVIS propagation, the results will be poor. A mix of stations using antennas which in between NVIS and Skywave (.2 to .5 wavelength) will provide for moderate NVIS results.
- NVIS doesn't work on all HF frequencies with the range to 12Mhz on a 24/7 basis. (Care must be exercised to pick an appropriate NVIS range frequency which supports propagation between point and A and B, the use of Propagation Prediction methods or ALE is highly recommended.)
- The frequency range which are best for NVIS is also where atmospheric noise is more of a problem, where antenna lengths are long and antenna bandwidths are relatively narrow for most command antenna types.
- Due to differences between daytime and nighttime propagation, a minimum of two, preferably three different frequencies must be used to ensure reliable around-the-clock NVIS communications. The best approach is to configure an ALE network of channels for automated ALE Link Quality Analysis selection of the operation frequency.

ANTENNA MAINTENANCE

Regarding maintenance, if you selected components appropriate to your location and year round environmental extremes, very little maintenance should be required. However, antenna systems consisting of transmission line and other components bolted together still need periodic maintenance.

The point where the antenna system sections are bolted together often wear and deteriorates with time. As the transmission line warms and cools with and without power, from day to night, and from summer to winter, the sections expand and contract. This expansion and contraction causes conductors to rub and wear. This wearing can generate a number of problems over time to include receive noise level increases and paths to ground that can cause momentary power shorts to ground and momentary loss of output power.

A physical inspection during good weather to spot discontinuities (breaks, shorts or impedance change) at some point along the feedline along with the use of an Antenna Analyzer (AEA, Autek, MFJ models or other) or the use of a Time Domain Reflectometer (TDR) periodically such as an AEA Cablemate TDR (<http://www.aea-wireless.com/tdr.htm>) or my old Tektronix 1502 in the maintenance of your antenna system will go a long way in guaranteeing that your antenna will continue to perform properly all year round and especially during the harsh winter months when physical access may be denied.

With a TDR, faults such as opens, shorts, or mismatches can be precisely located along the length of various cable (see: "Practical Radio Frequency Test & Measurement - A Technician's Handbook by Joseph J. Carr, ISBN: 0-7506-7161-0") and wire types used for transmission lines or in the case of long wire or random wire antenna and some other types depending on where measured the radiating part of the antenna as well.

The TDR launches a rectangular pulse toward the cable's end and waits for an echo signal. The time between the start of the pulse and the arrival of the echo is then converted in terms of distance, allowing the fault to be accurately located. An oscilloscope is typically used to obtain the elapsed time reading. A TDR can be configured using a (see: "HR Magazine June 87, Practically speaking: build your own time-domain reflectometer, Joe Carr, K4IPV") triggered sweep oscilloscope and a square wave generator set to produce a narrow pulse at specific intervals.

When just viewing transmission lines or antenna wire elements (such as when jacketed wire is used) the TDR can detect and display when properly calibrated the exact location to the foot where an open or short is located. There is an almost unlimited range of waveforms that may be encountered when using a TDR to look at an antenna system and numerous waveforms when just viewing transmission lines due to the various types of cable types which may be used. However a reflection with the same polarity indicates a fault with Open (high impedance) tendencies. A

reflection with the opposite polarity indicates a fault with Short (low impedance) tendencies. To get a better idea of how to interpret waveforms displayed by a TDR I recommend the web based tutorial at: <http://www.tscm.com/riwavef.html>

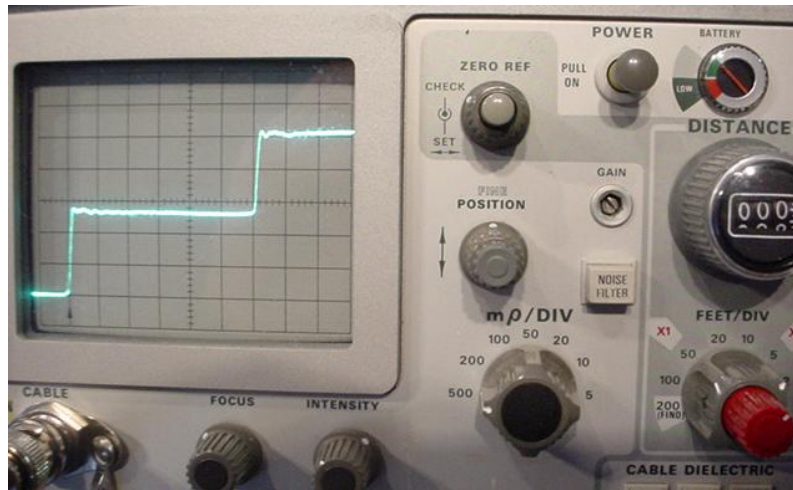

With every antenna type, a different type of characteristic reflection is achieved which produces a unique pattern on a TDR. You can record these (built in strip recorder, X/Y output, RS-232 port, digital camera or paper sketch by hand) patterns for the antenna system without knowing what every wiggle in the trace actually means. Later, before trouble develops, you can take another reading and compare the graphs to denote a change as a heads up to a problem that is about to develop and perform a physical inspection to determine why there is a change, its better to find a problem at its infancy and fix it then wait for a major antenna system failure.

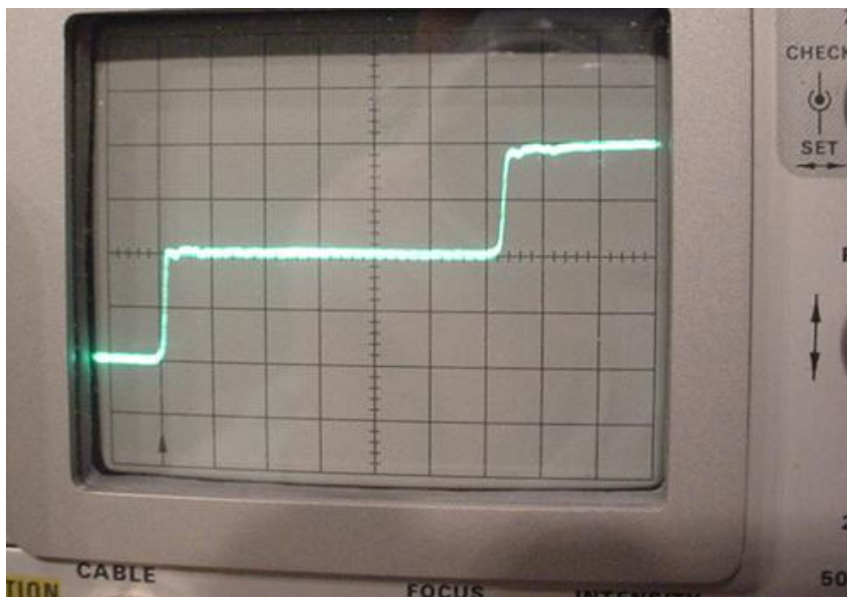

Sometimes the problem will show up in the antenna and not in the feedline, by looking at the recorded pattern from the antenna itself and noting that it has changed

from the original picture, this would of course require some antenna system disassembly and is thus reserved for actual troubleshooting. A TDR works with open or shorted cables and components, at the far end the display, you will see a decay down to zero with a shorted cable or a DC type antenna or shorted Balun etc. The use of a TDR to determine where a short or open is in a long run of cable is the fastest way I know of diagnosing such, many are hard to see with the open eye as we all know from experience.

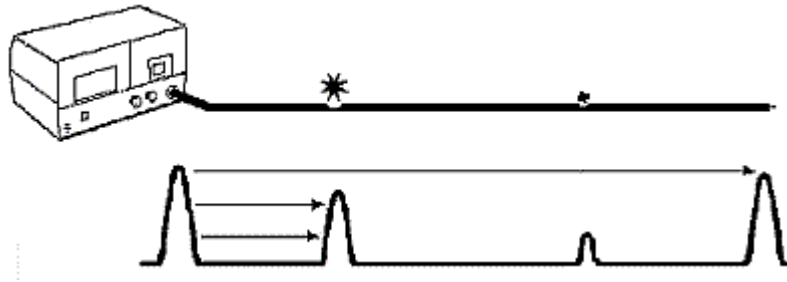

Sometimes a cable contains more than one faults, such as the shorts represented above. Multiple faults in a cable can be caused by many factors, including rodent damage, improper or faulty installation, construction, ground shift, or even structural flaws from the manufacturing process. If a fault is a complete open or a dead short, the TDR will read only to that point and not beyond. If the fault is not an open or short, the TDR may indicate the first fault and other faults further down the cable. In the case of a waveform TDR, the waveform signature of the cable will show most of the discontinuities, both large and small, along the length of the cable.